



INDUSTRIAL

HAZARDOUS  
AREAS

DATA ICT

RESIDENTIAL  
COMMERCIAL



**B&R Enclosures**  
**AUSRACK PLUS SERVER**

[brenclosures.com.au](http://brenclosures.com.au)

# Ausrack Plus Server

19 inch server cabinets

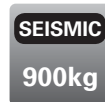
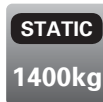

- Suitable for use in large data room applications that require a robust and fully featured server racking solution with free flowing movement.
- Essential platform for flexible computing solutions.
- Designed with a high load rating and inset corner posts.
- Combines versatility and strength with easy-to-use features.
- Inbuilt 65mm plinth
- Manufactured from:
  - Frame – 1.6mm zinc coated steel
  - Rail – 2.0mm zinc coated
  - Panel – 1.2mm zinc coated steel
- Powdercoated textured matte black.

Comes standard with:

- 4 x RU marked adjustable mounting rails
- Mesh doors (600mm wide cabinets)
- Front & rear split mesh doors (800mm wide cabinets)
- Removable side panels
- Lockable wing knob with 2-point locking (keyed to 92268)



## ORDERING GUIDE

Part Number	RU	Dimensions (mm)			Maximum Rail Depth <sup>^</sup>	Weight (kg)
		Height (A)	Width (B)	Depth (C)		
AS24U609*	24	1202	600	900	756	91.0
AS24U611*	24	1202	600	1100	956	97.5
AS40U609#	40	1913	600	900	756	123.0
AS40U611#	40	1913	600	1100	956	139.5
AS45U609#	45	2135	600	900	756	134.0
AS45U611#	45	2135	600	1100	956	149.0
AS40U809#	40	1913	800	900	756	132.0
AS40U811#	40	1913	800	1100	956	142.0
AS45U809#	45	2135	800	900	756	135.0
AS45U811#	45	2135	800	1100	956	145.0

\* 24RU cabinets also supplied with ARTF flat top cover

# 40 & 45RU cabinets are supplied with gland plates fitted into roof

<sup>^</sup> The maximum distance between mounting rails

## ACCESSORIES QUICK SELECTION

ACCESSORIES	Page No.
Doors	3-5
Top Covers	5
Side Panels	6
Privacy Panels	6
Cable Zones	7
Power Rails	7
Cable Management	8
Shelves	9
Cable Trays	9
Fans	10
General & Mounting Accessories	10
Airflow Efficiency Products	10-11

# Ausrack Plus Server

19 inch server cabinets

## TECHNICAL DRAWINGS

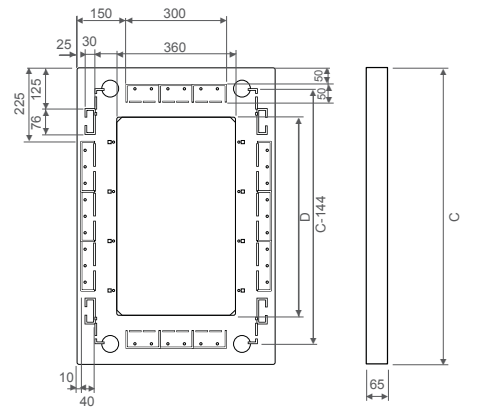
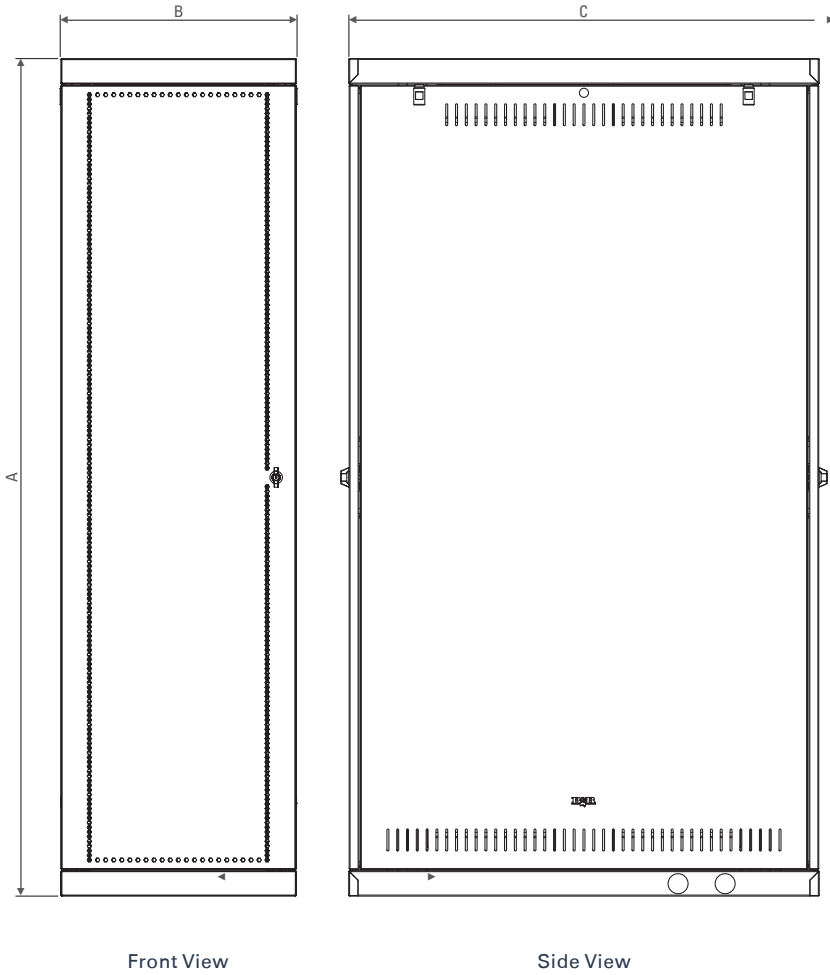

Top View

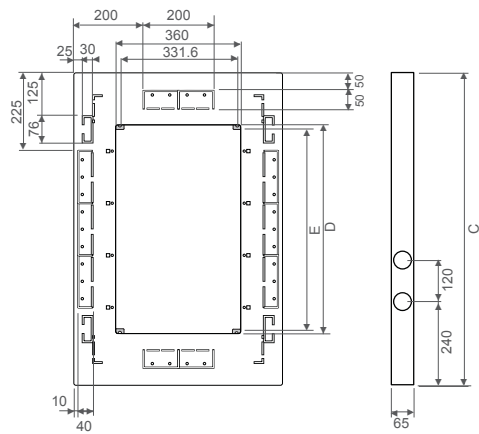

Bottom View

# Ausrack Plus Accessories

A range of accessories to suit Ausrack Plus

## Mesh Doors

To maximise airflow to the Ausrack Plus data cabinet, all mesh doors consist of 63% open mesh and include a lockable wing knob and two point locking as standard (keyed to 92268). Electronic remote controlled, monitored locking systems, swing handles, custom keying and 3-point locking (ARP3L) available on request.

Part Number	Description	To suit cabinets & frames		
		RU	Width (mm)	
ARDM18U06	Mesh steel doors - single (63% open mesh)	18	600	
ARDM18U08		18	800	
ARDM24U06		24	600	
ARDM24U08		24	800	
ARDM27U06		27	600	
ARDM27U08		27	800	
ARDM40U06		40	600	
ARDM40U08		40	800	
ARDM42U06		42	600	
ARDM42U08		42	800	
ARDM45U06		45	600	
ARDM45U08		45	800	
ARDM47U06		47	600	
ARDM47U08		47	800	
ARDM48U06		48	600	
ARDM48U08		48	800	
ARDD18U06		Mesh steel door – split (63% open mesh)	18	600
ARDD18U08			18	800
ARDD24U06			24	600
ARDD24U08			24	800
ARDD27U06	27		600	
ARDD27U08	27		800	
ARDD40U06	40		600	
ARDD40U08	40		800	
ARDD42U06	42		600	
ARDD42U08	42		800	
ARDD45U06	45		600	
ARDD45U08	45		800	
ARDD47U06	47	600		
ARDD47U08	47	800		
ARDD48U06	48	600		
ARDD48U08	48	800		

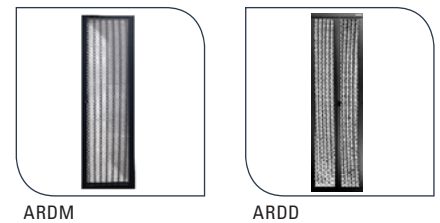

## Pressure Loss vs Impact Velocity for Various Open Area Perforated Plates

Source: Industrial Perforators Association (1993)

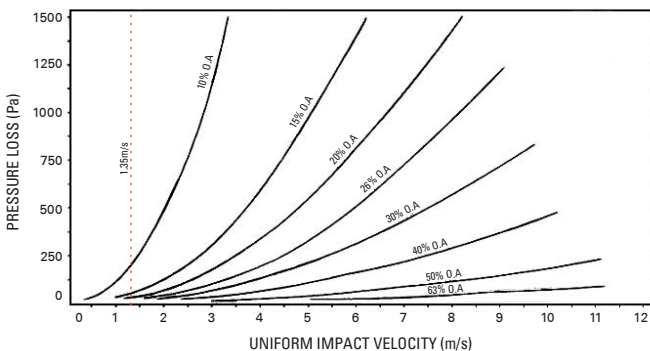

### Why 63% mesh doors will work for you.

In many applications of mesh doors, the pressure loss through the door is one of the design considerations. In most situations the air impact velocity on the door won't be much over 1.5m/s.

As seen in the graph, B&R's 63% mesh doors will have a negligible pressure drop at these velocities. Most computer room air conditioners generate more than 20Pa of pressure, more than enough to overcome the pressure drop at the door in a containment situation.

For example, in a data centre environment, a 15kW heat load in a 45RU cabinet would require 3500m<sup>3</sup>/h of airflow. This is equivalent of a 1.35m/s impact velocity. In a containment situation with a positive aisle pressure this will be more than the pressure drop of the doors and the equipment will receive sufficient air flow.

With such a negligible restriction to airflow, the higher percentages available in the market have no real advantage. The 63% mesh was developed as a cross over point of functional performance and higher security.

# Ausrack Plus Accessories

A range of accessories to suit Ausrack Plus

## Window Doors

Window doors are available with an acrylic insert panel. An option is also available for venting for airflow. Suitable for all Ausrack Plus data cabinets, all doors include a lockable wing knob and two point locking as standard. (keyed to 92268) Electronic remote controlled, monitored locking systems, swing handles, custom keying and 3-point locking (ARP3L) are available on request.

Part Number	Description	To suit cabinets & frames		
		RU	Width (mm)	
ARDA18U06	Window door, acrylic	18	600	
ARDA18U08		18	800	
ARDA24U06		24	600	
ARDA24U08		24	800	
ARDA27U06		27	600	
ARDA27U08		27	800	
ARDA40U06		40	600	
ARDA40U08		40	800	
ARDA42U06		42	600	
ARDA42U08		42	800	
ARDA45U06		45	600	
ARDA45U08		45	800	
ARDA47U06		47	600	
ARDA47U08		47	800	
ARDA48U06		48	600	
ARDA48U08		48	800	
ARAV18U06		Window door, acrylic – vented	18	600
ARAV18U08			18	800
ARAV24U06			24	600
ARAV24U08			24	800
ARAV27U06	27		600	
ARAV27U08	27		800	
ARAV40U06	40		600	
ARAV40U08	40		800	
ARAV42U06	42		600	
ARAV42U08	42		800	
ARAV45U06	45		600	
ARAV45U08	45		800	
ARAV47U06	47		600	
ARAV47U08	47		800	
ARAV48U06	48		600	
ARAV48U08	48		800	



ARDA



ARAV

# Ausrack Plus Accessories

A range of accessories to suit Ausrack Plus

## Steel Doors

Suitable for use on all Ausrack Plus data cabinets. All steel doors include a lockable wing knob and two point locking as standard (keyed to 92268). Electronic remote controlled, monitored locking systems, swing handles, custom keying and 3-point locking (ARP3L) are available on request.

Part Number	Description	To suit cabinets & frames		
		RU	Width (mm)	
ARDS18U06	Steel doors – single	18	600	
ARDS18U08		18	800	
ARDS24U06		24	600	
ARDS24U08		24	800	
ARDS27U06		27	600	
ARDS27U08		27	800	
ARDS40U06		40	600	
ARDS40U08		40	800	
ARDS42U06		42	600	
ARDS42U08		42	800	
ARDS45U06		45	600	
ARDS45U08		45	800	
ARDS47U06		47	600	
ARDS47U08		47	800	
ARDS48U06		48	600	
ARDS48U08		48	800	
ARSS24U06		Steel doors – split	24	600
ARSS24U08			24	800
ARSS40U06	40		600	
ARSS40U08	40		800	
ARSS45U06	45		600	
ARSS45U08	45		800	



ARDS

## Top Covers

Used to enclose the frame's top plinth section. Raised top covers feature ventilation for airflow and can be used in conjunction with fans (see page 43).

Part Number	Type	To suit cabinets & frames	
		RU	Width (mm)
ARTF606	Flat	600	600
ARTF609		600	900
ARTF611		600	1100
ARTF809		800	900
ARTF811		800	1100
ARTR606	Raised	600	600
ARTR609		600	900
ARTR611		600	1100
ARTR809		800	900
ARTR811		800	1100

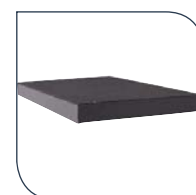

ARTF

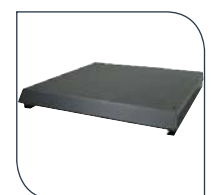

ARTR

# Ausrack Plus Accessories

A range of accessories to suit Ausrack Plus

## Side Cladding

**Side panels** include venting and are easy-to-fit using locating pins and slam latches. They can be locked into the frame for added security using either an external key lock kit (ARSPL) or an internal latch kit (ARSPIL).

**Privacy Panels** are a secure method of providing security to a single cabinet when cabinets are bayed together, by using either a non-removable panel, or a removable set of panels. These panels can also segregate air to ensure no cross cabinet mixing.

Part Number		To suit cabinets & frames	
Side Panels	Privacy Panels	RU	Depth (mm)
ARP18U06		18	600
ARP18U08		18	800
ARP18U09		18	900
ARP18U10		18	1000
ARP18U11		18	1100
ARP18U12		18	1200
ARP24U06		24	600
ARP24U08		24	800
ARP24U09		24	900
ARP24U10		24	1000
ARP24U11		24	1100
ARP24U12		24	1200
ARP27U06		27	600
ARP27U08		27	800
ARP27U09		27	900
ARP27U10		27	1000
ARP27U11		27	1100
ARP27U12		27	1200
ARP40U06	ARPP40U06	40	600
ARP40U08	ARPP40U08	40	800
ARP40U09	ARPP40U09	40	900
ARP40U10	ARPP40U10	40	1000
ARP40U11	ARPP40U11	40	1100
ARP40U12	ARPP40U12	40	1200
ARP42U06	ARPP42U06	42	600
ARP42U08	ARPP42U08	42	800
ARP42U09	ARPP42U09	42	900
ARP42U10	ARPP42U10	42	1000
ARP42U11	ARPP42U11	42	1100
ARP42U12	ARPP42U12	42	1200
ARP45U06	ARPP45U06	45	600
ARP45U08	ARPP45U08	45	800
ARP45U09	ARPP45U09	45	900
ARP45U10	ARPP45U10	45	1000
ARP45U11	ARPP45U11	45	1100
ARP45U12	ARPP45U12	45	1200
ARP47U06	ARPP47U06	47	600
ARP47U08	ARPP47U08	47	800
ARP47U09	ARPP47U09	47	900
ARP47U10	ARPP47U10	47	1000
ARP47U11	ARPP47U11	47	1100
ARP47U12	ARPP47U12	47	1200
ARP48U06	ARPP48U06	48	600
ARP48U08	ARPP48U08	48	800
ARP48U09	ARPP48U09	48	900
ARP48U10	ARPP48U10	48	1000
ARP48U11	ARPP48U11	48	1100
ARP48U12	ARPP48U12	48	1200



ARP



ARPP



# Ausrack Plus Accessories

A range of accessories to suit Ausrack Plus



## Cable Zones

Designed for mounting onto the side of cabinet optimising accessibility and space available for cabling and cable management products. They can be incorporated into suites and are available for all 40RU and 45RU cabinets and frames. Consist of top and bottom plinths, front and rear cover panels and all fixings required for installation onto the rack.

Part Number	Width (mm)	To suit cabinets & frames	
		RU	Depth (mm)
AC40U06	100	40	600
AC40U09	100	40	900
AC40U11	100	40	1100
AC45U06	100	45	600
AC45U09	100	45	900
AC45U11	100	45	1100
AC45U12	100	45	1200
AC40U206 <sup>▲</sup>	200	40	600
AC40U209	200	40	900
AC40U211	200	40	1100
AC45U206 <sup>▲</sup>	200	45	600
AC45U209	200	45	900
AC45U211	200	45	1100
AC45U212	200	45	1200

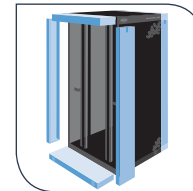

Cable Zones

<sup>▲</sup> Available on request

## Power Rails

Suitable for use in all Ausrack cabinets. Available in 6, 10, 20-way 10A SAA outlets and 10-way IEC-C13 and tested to Australian Standards. Other options, switched and intelligent PDUs are available on request.

Part Number	Description	Orientation	Type of Outlets	Type of Input Plug	RU	Circuit Breaker
ARPRH61010	6 x 10A Outlet 10A Plug	Horizontal	SAA Outlet	10A SAA plug	1	10A
ARPRH61015	6 x 10A Outlet 15A Plug		SAA Outlet	15A SAA plug	1	15A
ARPRH101010	10 x 10A Outlet 10A Plug		SAA Outlet	10A SAA plug	2	10A
ARPRH101015	10 x 10A Outlet 15A Plug		SAA Outlet	15A SAA plug	2	15A
ARPRV61010	6 x 10A Outlet 10A Plug	Vertical	SAA Outlet	10A SAA plug	10	10A
ARPRV61015	6 x 10A Outlet 15A Plug		SAA Outlet	15A SAA plug	10	15A
ARPRV101010	10 x 10A Outlet 10A Plug		SAA Outlet	10A SAA plug	16	10A
ARPRV101015	10 x 10A Outlet 15A Plug		SAA Outlet	15A SAA plug	16	15A
ARPRV201010	20 x 10A Outlet 10A Plug		SAA Outlet	10A SAA plug	28	10A
ARPRV201015	20 x 10A Outlet 15A Plug		SAA Outlet	15A SAA plug	28	15A
ARPRV10C13C14	10 x 10A C13, 10A C14 Plug		IEC320-C13	IEC320-C14	10	10A
ARPRV10C13C20	10 x 10A C13, 16A C20 Plug		IEC320-C13	IEC320-C20	10	16A
ARPRHS61010	6 x 10A Outlet, 10A Plug surge protected	Horizontal	SAA Outlet	10A SAA plug	1	10A
ARPRHS61015	6 x 10A Outlet, 15A Plug surge protected		SAA Outlet	15A SAA plug	1	15A
ARPRVS101015	10 x 10A Outlet 10A Plug surge protected	Vertical	SAA Outlet	15A SAA plug	17	15A



Power Rails

## Customised power rail solutions

If you have a requirement outside of our standard offer please contact your local B&R sales office and we can assist in providing a customised solution. No matter the socket type, plug type, colour or protection level, B&R can service your needs suitable for your specific application. At B&R we are proud to offer Australian Made custom PDUs to suit your detailed requirements.

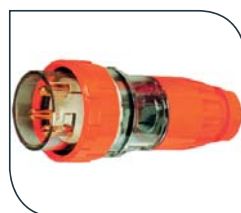



# Ausrack Plus Accessories

## A range of accessories to suit Ausrack Plus

### Cable Management

Cable management can be incorporated into Ausrack cabinets and can be used for horizontal and vertical cable management of high density cabling.

Product	Part Number	Description	RU	Width (mm)	To suit enclosure
Horizontal Cable Management	ARHCMF1U	Cable fingers and cover panel	1	–	All Ausrack Plus products
	ARHCMF2U		2	–	
	ARHCMF4U		4	–	
Vertical Cable Management Fingers	ARVCMF40U	Cable fingers and connection bracket	40	–	All Ausrack Plus products
	ARVCMF45U		45	–	
Vertical Cable Management System	ARVCMS40U10	U-Channel system with cable fingers, connection brackets and cover flaps	40	100	Ausrack Plus products 800mm wide cabinets or with use of cable zones
	ARVCMS40U20		40	200	
	ARVCMS45U10		45	100	
	ARVCMS45U20		45	200	
Horizontal Cable Management Rings	ARPCMH1U	55mm x 30mm ring, 1RU	1	–	All Ausrack Plus products
Cable Management Rings	ARPCMR2S	155mm deep, single zone	–	–	100mm cable zone
	ARPCMR3S	300mm deep, single zone	–	–	100mm cable zone
	ARPCMR3D	300mm deep, two zone	–	–	200mm cable zone
Cable Management Hanger	ARPCMP24	24 patch lead hanger, 597mm	–	–	Stand alone product wall mount

Cable Capacity

	Cat5e	Cat6	Cat6e	Cat7	Fibre	Power 10A	Power 15A
Diameter (mm) <sup>#</sup>	5.6	6.3	8.4	7.6	3	7	8.5
Saturation*	50%	50%	50%	50%	60%	40%	40%
ARHCMF1U	31	25	14	17	129	16	11
ARHCMF2U	99	79	44	54	414	51	35
ARHCMF4U	227	179	101	123	947	116	79
ARPCMH1U	23	18	10	13	94	12	8
ARVCMSxxU10	269	213	120	146	1125	138	94
ARVCMSxxU20	597	472	266	324	2495	306	208
ARPCMR2S	205	162	92	112	858	105	72
ARPCMR3S	431	340	192	234	1799	221	150
ARPCMR3D	1167	922	519	634	4877	598	405



Please Note: B&R Enclosures does not accept liability for any errors within the above table.

<sup>#</sup>These are nominal values for the OD of cable as sizes may vary.

\* Recommended maximum cable saturation.

# Ausrack Plus Accessories

A range of accessories to suit Ausrack Plus



## Shelves

Providing a stable platform for other miscellaneous gear, shelving mounts off the 19" rack rails. All shelves are vented to allow vertical airflow.

Part Number	Description	RU	Depth (mm)	Load Rating (kg)	To suit cabinets & frames (mm)
ARC210	Cantilever	2	210	10	All
ARC360		2	360	10	All
ARPFL600	Fixed, light duty	1	450	50	600mm deep
ARPFL800 <sup>▲</sup>		1	650	50	800mm deep
ARPFL900 <sup>▲</sup>		1	750	50	900mm deep
ARPFL1000 <sup>▲</sup>		1	850	50	1000mm deep
ARPFL1100 <sup>▲</sup>		1	950	50	1100mm deep
ARPFL1200 <sup>▲</sup>		1	1050	50	1200mm deep
ARPFH600 <sup>▲</sup>	Fixed, heavy duty	1	450	100	600mm deep
ARPFH800 <sup>▲</sup>		1	650	100	800mm deep
ARPFH900 <sup>▲</sup>		1	750	100	900mm deep
ARPFH1000 <sup>▲</sup>		1	850	100	1000mm deep
ARPFH1100 <sup>▲</sup>		1	950	100	1100mm deep
ARPFH1200 <sup>▲</sup>		1	1050	100	1200mm deep
ARTF450	Telescopic, full extension	1	450	20	600mm deep
ARTF750		1	750	20	900mm deep
ARTF950		1	950	20	1100mm deep
ARTH450	Telescopic, half extension	1	450	40	600mm deep
ARTH750		1	750	40	900mm deep
ARTH950		1	950	40	1100mm deep
ARKBC	Keyboard pivot tray accessory*	2	-	-	All

<sup>▲</sup> Available on request

\* Requires half extension telescopic shelf



ARC210

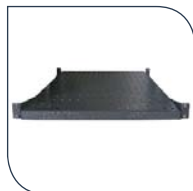

ARFL



ARFH



ARKBC

## Cable Trays

An effective way to keep vertical cable runs neat and tidy.

Part Number	Cable Mounting Width (mm)	To suit cabinet RU
ARC24U15	150	24
ARC24U30	300	24
ARC40U15	150	40
ARC40U30	300	40
ARC45U15	150	45
ARC45U30	300	45

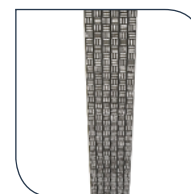

ARC45U30

# Ausrack Plus Accessories

A range of accessories to suit Ausrack Plus

## Fans

Two and four unit fan kits install into the roof or bottom plinth. The two unit fan kit can also be fitted into the equipment rails. All fans are supplied with 2m flex and 10A SAA plug. Whisper quiet options are available on request.

Product	Part Number	Description	RU
Fan kit – 2 unit	ARPAF2	High speed, axial	1
	ARPAF2T	High speed, axial, with integrated thermostat	1
	ARPAF2WT	Whisper quiet with integrated thermostat	1
Fan kit – 4 unit*	ARPAF4	High speed, axial	1
	ARPAF4T	High speed, axial, with integrated thermostat	1
	ARPAF4WT	Whisper quiet with integrated thermostat	1

\* Fitting in roof and base only



ARPAF2T



ARPAF4T



ARPAF2



ARPAF4

## General & Mounting Accessories

Part Number	Product	Description
ARPRK	Heavy duty roller kit	800kg load, adds 10mm to height of cabinet
ARPFK	Adjustable foot kit	–
ARPBK	Baying kit	Consists of 4 brackets
ARP3L	3 point locking kit	Suits all door except split doors
ARSPL	Side panel lock kit	Keyed to 92208
ARSPIL	Side panel internal latch kit	Pack of two
ARMS06	Mounting rail horizontal support arm	To suit 600mm deep
ARMS09		To suit 900mm deep
ARMS11		To suit 1100mm deep
ARMR12U	Mounting rail – pair (powdercoated)	12RU
ARMR24U		24RU
ARMR40U		40RU
ARMR45U		45RU
ARCN	Cage nuts, screws and washers	Pack of 50
ARSTUD100 <sup>▲</sup>	Rack Studs	Pack of 100
ARSTUD20 <sup>▲</sup>		Pack of 20

<sup>▲</sup> Available on request

## Vertical Brush Strips

Designed to control airflow in the rack. They provide a barrier between the front of the frame and hot exhaust air at the rear, between the post and the side panel whilst also allowing cable access. Each strip attaches to the post and extends to the side panel of the cabinet.

Part Number	To suit cabinets & frames	
	RU	Width (mm)
ARPBS40U06	40	600
ARPBS40U08	40	800
ARPBS45U06	45	600
ARPBS45U08	45	800



ARPBS

# Ausrack Plus Accessories

A range of accessories to suit Ausrack Plus



## Ezibrush™ Strips

Keeps hot exhaust air away from cool intake air, extending the life of your equipment. These panels have a brush strip overhanging the 1RU size by an extra 5mm allowing simple management of air gaps when placed alongside other equipment.

Part Number	Description	RU
ARBPB1U	Horizontal, 19" black	1



ARBPB1U

## Eziblank Blanking Panels

The Ausrack 6RU adjustable tool-less blanking panels simply snap to the size you need and pushes onto the 19" mounting rails. The blanking panels can be easily snapped in 1RU increments to fit any gap. Made from UL94 fire rated and anti-static ABS plastic.

Part Number	Description	RU
ARBP6U	Supplied as 6 x 1RU plastic panels	1



ARBP6U

## Metal Blanking Panels

Used to control airflow within the rack. They are manufactured from 1.2mm steel with a powdercoated matt black surface finish.

Part Number	RU	Dimensions (mm)	
		Height	Width
EBP1U	1	44	483
EBP2U	2	88	483
EBP3U	3	132	483
EBP4U	4	177	483
EBP5U	5	222	483
EBP6U	6	266	483



EBP

## Cable Zone Blanking Plates

Designed to seal the front section of racks bayed with cable zones from hot exhaust air at the rear of the cabinet. They extend between the posts of the two adjoining racks over the cable zone to the full height of the rack.

Part Number	Width (mm)	To suit cabinets & frames
ARPBP40U100	100	40RU
ARPBP40U200	200	40RU
ARPBP45U100	100	45RU
ARPBP45U200	200	45RU

## AUSTRALIA

### Sales

T: 1300 Enclosures (1300 362 567)  
F: 1300 796 599  
E: sales@brenclosures.com.au  
**brenclosures.com.au**

### QUEENSLAND

Brisbane Manufacturing, Sales & Warehouse  
51 Stradbroke Street  
Heathwood QLD 4110  
(PO Box 1151)  
Browns Plains BC QLD 4118  
T: +61 7 3714 1111  
E: salesqld@brenclosures.com.au

### NORTH QUEENSLAND

Townsville Sales & Warehouse  
Unit 4 / 780 Ingham Rd, Mount Louisa  
(PO Box 7615),  
Garbutt QLD 4814  
T: +61 7 4727 1900  
E: salestvl@brenclosures.com.au

### NEW SOUTH WALES

NSW & ACT Sales & Warehouse  
Unit 12 / 100 Belmore Road North  
(PO Box 192)  
Riverwood NSW 2210  
T: +61 2 9915 9555  
E: salesnsw@brenclosures.com.au

### NEWCASTLE Distribution

Ross Joice Agencies Pty Ltd  
109-111 Broadmeadow Road  
Broadmeadow NSW 2292  
T: +61 2 4961 4433

### VICTORIA

VIC & TAS Sales & Warehouse  
50-52 Sunmore Close  
Heatherton VIC 3202  
T: +61 3 9552 0552  
E: salesvic@brenclosures.com.au

### TASMANIA Distribution

W P Martin Pty Ltd  
85 Elizabeth Street  
Launceston TAS 7250  
T: +61 3 6331 5545

### SOUTH AUSTRALIA

SA & NT Manufacturing, Sales & Warehouse  
505 Grand Junction Road  
Wingfield SA 5013  
T: +61 8 8417 6222  
E: salessa@brenclosures.com.au

### NORTHERN TERRITORY Distribution

Jewell Distributors Pty Ltd  
Cnr Hidden Valley & Beaton Roads  
Berrimah NT 0828  
T: +61 8 8947 0870

### WESTERN AUSTRALIA

WA Sales Office & Warehouse  
6 Montgomery Way  
Malaga WA 6090  
T: +61 8 6310 4777  
E: saleswa@brenclosures.com.au

## NEW ZEALAND

### Sales

B&R Enclosures Limited  
T: 0800 Enclosures (0800 362 567)  
E: sales@brenclosures.co.nz  
**brenclosures.co.nz**

### AUCKLAND Distribution

Matchmaster  
Unit 6/103 Cryers Road  
East Tamaki Auckland NZ 2013  
T: +64 9 265 2097  
E: sales@brenclosures.co.nz

### CHRISTCHURCH Distribution

Matchmaster  
17 Washbournes Road  
Wigram Christchurch NZ 8042  
T: +64 3 348 0659  
E: sales@brenclosures.co.nz

## CHINA

B&R Enclosures (Suzhou) Co. Ltd  
E: sales@brenclosures.com.cn  
**brenclosures.com.cn**

### SUZHOU

Manufacturing, Sales & Warehouse  
Building 45, Chuangtou  
Industrial Zone, SIP,  
Suzhou 215122  
PEOPLE'S REPUBLIC OF CHINA  
T: +86 512 8718 2139  
E: sales@brenclosures.com.cn

## SOUTH EAST ASIA

### Sales

Manufacturing, Sales & Warehouse  
B&R Enclosures SDN BHD  
No.38-1, Puchong Gateway Square,  
Jalan Suria Puchong 4  
Pusat Perniagaan Suria Puchong  
47110, Puchong, Selangor, Malaysia  
M: +601 2350 2568  
T: +603 8958 3923  
E: sales@brenclosures.com.my  
**brenclosures.com.my**

### MALAYSIA Distribution

MTW Controls SDN BHD  
42 Puchong Gateway Square  
Jalan Suria Puchong 4  
47110 Puchong Darul Ehsan  
Kuala Lumpur, MALAYSIA  
M: +601 227 7637 3  
E: ckwoon@mtwcontrols.com.my

### INDONESIA Distribution (Office)

P.T Reitama Engineering  
Jl. Margonda Raya No. 139  
Depok, INDONESIA 16413  
T: +62 21 7783 7078 (Hunting)  
M: +62 81 1979 7772  
E: sales@reitama-engineering.com

## MIDDLE EAST

### Sales

Manufacturing, Sales & Warehouse  
B&R Gulf  
Factory No. 12, Modon Buildings  
King Salman Road, Industrial Area 3  
Dammam, Kingdom of Saudi Arabia  
T: +96 638 128 691 or +96 650 349 6592  
E: sales@brgulf.com.sa  
**brgulf.com.sa**

### UAE Distribution

Engineering Support Systems Est.  
PO Box 33904 Defence Street  
Ashtel Mobile Shop Bldg.  
Mezzanine Floor, Room M2  
Abu Dhabi, UNITED ARAB EMIRATES  
T: +971 2641 1844  
E: esse@emirates.net.ae

### OMAN Distribution

Global Corp Enterprices LLC  
PO Box 1524  
Al Khuwair, OMAN  
M: +968 9929 4323  
E: rakesh@globalcorpoman.com

### QATAR Distribution

Petrogulf Qatar  
WLL Doha  
QATAR  
T: +974 4435 0151  
E: amit@petrogulf.org